

Building tomorrow today

Insulation solutions
for windows, doors,
and facades.

We are your partner
for any system and
any challenge –
worldwide.

Contents

About us	4
Global experience	6
Thermal break	8
Standard and tailored solutions	10
Overview	12
Improved thermal insulations	14
Streamlined processing	16
Advanced functionality	18
Facade solutions	20
Our materials	22
Service, support and testing	24
Cooperations and certifications	26
Contacts	27



Let's talk Technoform



What we do

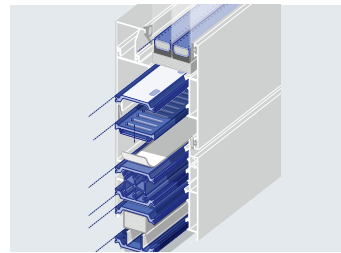

Materials and solutions



Technoform knowledge

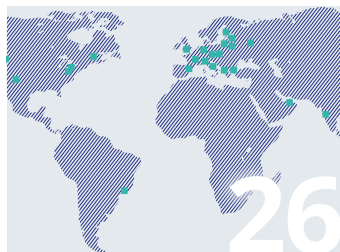

Technology pool

Hello, it's us, Technoform

As a family company, we know that people empower every business. We firmly believe that the best ideas are always born together. We are Technoform – 1,400 and growing, dedicated innovators that work for our customers worldwide.

Understanding what drives customers and markets since 1969, we develop leading solutions collaboratively. Providing 100 % reliability and quality on all levels, we offer the same level of high-quality services and solutions all around the world. 45 sites in over 40 countries ensure continuous supply wherever you are.

Performing 360° precision and 1,000+ skills, our highly trained team turns individual needs into tailored technological solutions. Delivering quantities from 1 to 1,000,000, our customers can rely on receiving the best available package of quality, quantity, time, and price.



We invite you to browse through this brochure and find out how we can support your personal vision.



Our everyday business? Finding solutions for you

In a fast-paced industry landscape new ideas and solutions are the currency that matters. Markets emerge, businesses transform, processes change. At Technoform, we unleash the full potential of people and their ideas across a global network to meet today's challenges collaboratively. We are people with a passion for plastics solutions. And in plastics extrusion we excel.

Our unique high-precision extrusion process allows us to form the most complex plastics – including those typically only suitable for injection molding. As a result, we are proud to offer outstanding technical characteristics that go far beyond the ordinary: extremely smooth surfaces, uniquely sharp contours, the lowest tolerances, the highest precision, and various custom material properties you would not usually expect from a plastic solution. In a nutshell: we always look for the perfect solution for you.

Take a look around – we are closer than you may think

Providing holistic knowledge and technical expertise, we are the can-do partner and problem solver for various industries. This spans from thermal edge bond solutions for architects, building planners, and manufacturers of insulating glass units (IGUs), a vast range of insulation solutions for aluminum windows, doors, and facades, to high-precision plastic profile solutions and system components for the automotive, aviation, and electrical engineering industries – just to name a few.



**Simply mentioning
that we specialize in
plastic extrusion is
an understatement.**

Your cooperation with us – a true partnership



Know-how

With over 40 years of experience we offer you a vast amount of knowledge and how-to in the development of efficient thermal break systems.



Service

We don't consider you just a customer but a partner. Therefore, we are constantly improving our processes and services to always fulfil your requirements and meet your needs.



Experience

We continuously scan what we develop in our global network and find inspiration for innovative insulation solutions. That's why we offer the major variety of products and materials to help our customers to fulfil every markets' request.



Research and development

As a pioneer in the development of insulation profiles, we always continue our search for optimized and tailored solutions. Thus, we guarantee you to find the best possible result for every challenge.



Quality

Quality is key for us. That is why we have implemented the ISO 9001 in 2001 (recertification in 2015) as well as the aTg certification. Thanks to the standardization of the processes, our products can be made in any of our production plants with no variation in quality.



Reference catalogue

Our reference catalogue is the most comprehensive one worldwide. Thanks to our long-term cooperation, we have developed more than 800 standard references that allow us to offer you multiple solutions.



“Every market has its own challenges – and we offer solutions for systems that perfectly match these requirements.”

Just imagine a material perfectly suited for the application in windows, doors, and facade systems. Excellent stability, maintenance-free handling, and almost unlimited recyclability – that’s what aluminum has to offer. And yet there is one severe disadvantage: a high degree of heat conductivity, leading to a great loss of energy.

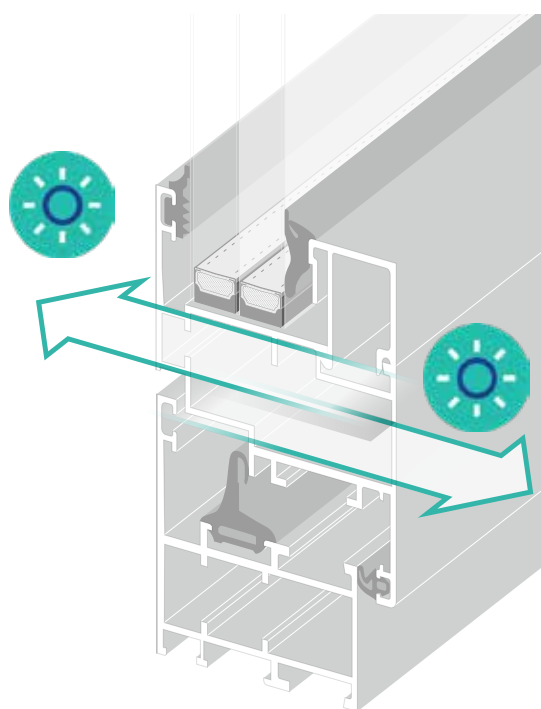

No thermal break

Without a thermal break, aluminum allows a big heat flow, which leads to a huge energy loss. In summer, the frame heats up and transfers the heat to the inside of the building and in winter, precious heat is lost.

Time for a revolution

Sounds like a bad decision to use the highly conductive aluminum for windows? To us, it sounds like a challenge to optimize its use. Therefore, some 40 years ago we started a technical revolution. By using small polyamide profiles, we substantially minimized the direct heat exchange. Thus, the so-called “thermal break” was created.

But how does it work? By replacing the direct connection of the aluminum elements on the inside and outside with our high precision polyamide profiles. The low heat conductivity leads to the thermal break of the inner and outer parts. At the same time, our insulation profiles guarantee outstanding stability and optimized mechanical performance.

But for us, good is not good enough and we want to take it a step further. Our goal: we want to combine a customized design with the lowest possible U-value. Let the next pages inspire you!

Thermal break

Connecting aluminum profiles to each other with polyamide profiles prevents the direct exchange of heat. Cavities inside the profiles, for example, make it possible to minimize the exchange of convection or radiant heat and to achieve optimum efficiency.

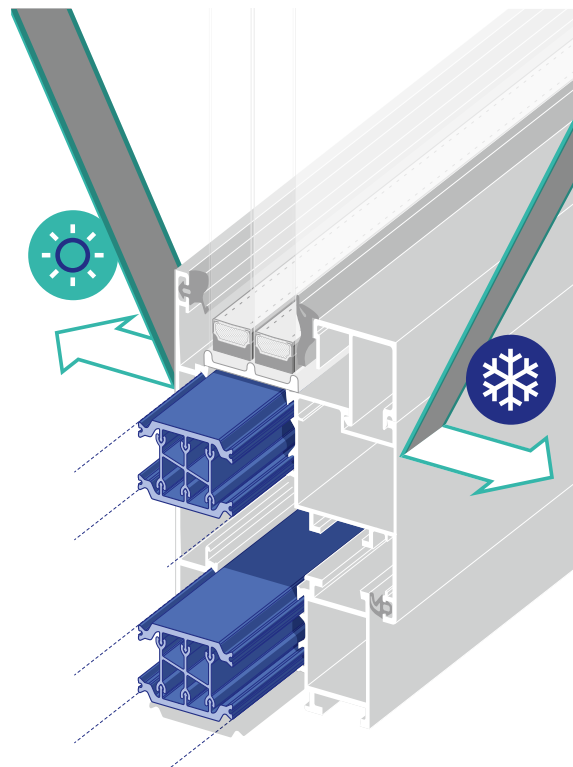

Standard or tailored – with us you are always right

Our core competence? Making your system future-ready

Ensuring sustainability is at the heart of what we do. For over 40 years, we have set our focus on creating our innovative, high-precision polyamide-based insulation profiles for aluminum windows, doors, and facades. Thus, we have helped improve quality and comfort, while delivering energy savings and reducing CO₂ emissions worldwide.

To achieve this, we have dedicated our work to create the so-called thermal break. Since customer satisfaction is of great importance to us, we offer more than 800 freely available geometries for various markets and needs. You can always rely on high quality solutions and a rapid supply in any length and quantity you need – wherever you are. 14 global production sites and 45 sales offices around the world make sure we are always near you.

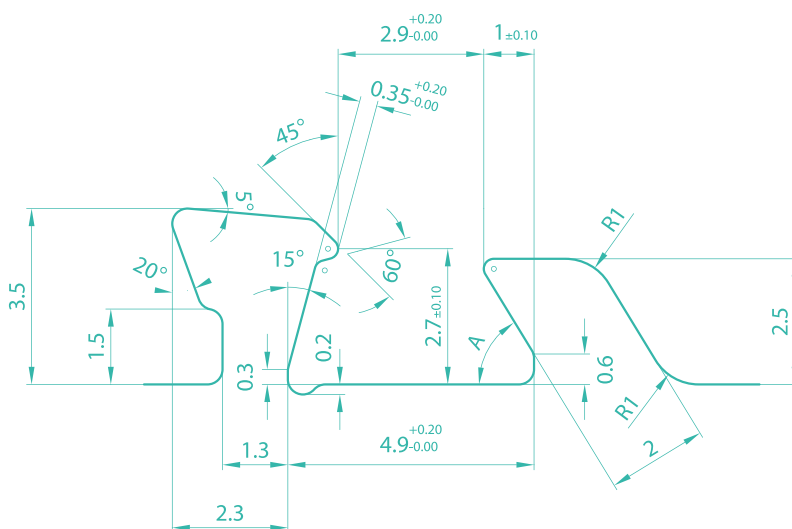

Radii ° = R0,2 | Others = R0,3
Angle A = 58,6° for production max. 60°

Technoform aluminum standard groove

Thanks to our long-standing expertise we have developed a cost-efficient and precise way to offer a great variety of standard solutions. And yes, when we talk about precision we mean exact calculation, determination of the correct angle and simulation of the product size. Everything that is required to match your needs.

A specific request? No problem, we can find a tailored solution

You need greater flexibility, or do you have a challenging situation where special adjustments are needed? Then we are your can-do partner to offer you help right away! Our tailored insulating profiles are developed for exclusive use according to your specific requirements, emerging daily from the close development partnership we enjoy with each customer.

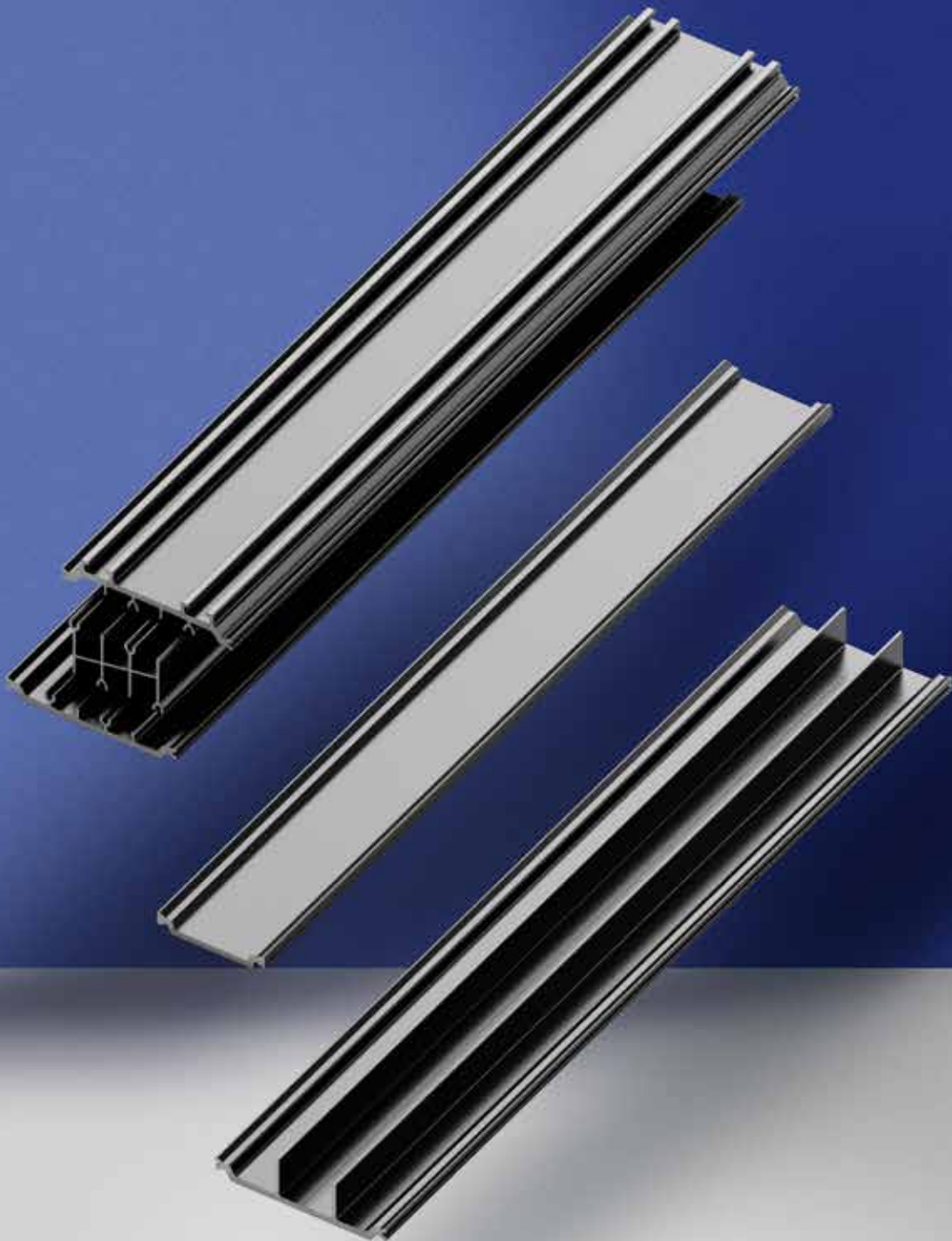

**When it comes to
thermal insulation, we
always look for the next
level of excellence.**

Your easy access to understanding thermal break

Solutions for thermal break look like rocket science to you? To help you understand what we can do for you, we provide you with an exemplary illustration of how to integrate most of our solutions into systems to solve challenging requirements. Step by step we will explain the different parts and options to you.

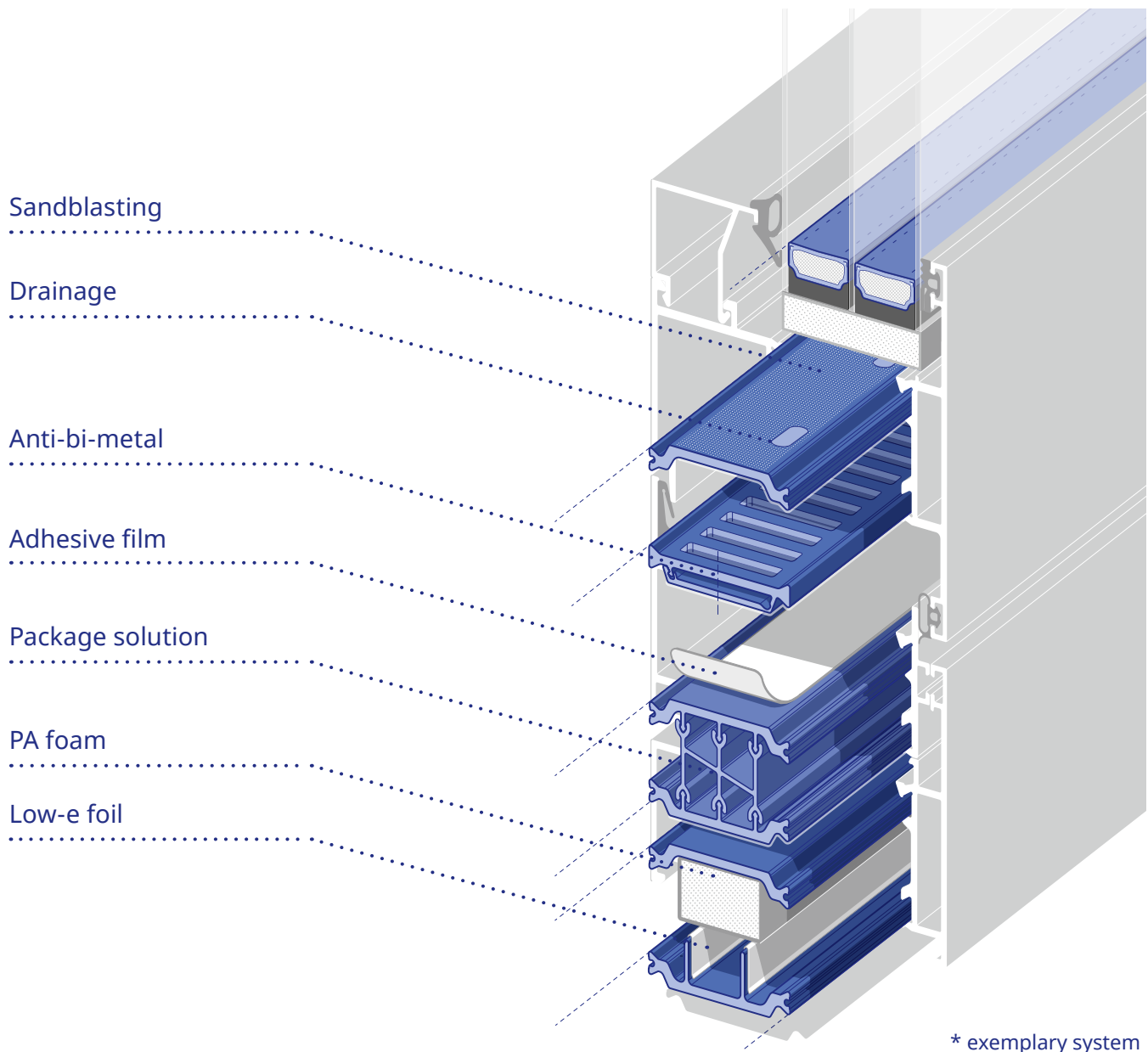

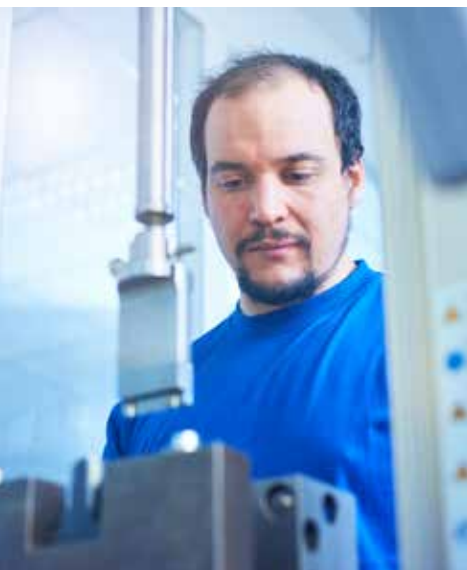

In the search for the lowest possible U-value, there is often potential for improvement in window, door, and facade systems. Separating the aluminum parts in windows is the beginning of the journey, but radiation and convection still present significant challenges to insulation. Optimization of the insulation zone is the key for highest energy efficiency. This could be achieved through using one of our standard profiles with hollow chambers or fins (noses) to reduce air flow and energy loss.

When good is not enough, one of our three special approaches can further optimize the insulation zone.

**“Every system can be optimized –
and we have both the tools and the
experience for the best solution.”**

Three approaches for best performance

Our three approaches to thermal optimization make sure that we take your needs into account, from the production system, right the way through to structural and environmental considerations. Let us work with you to find the right combination of solutions to reach your targets.

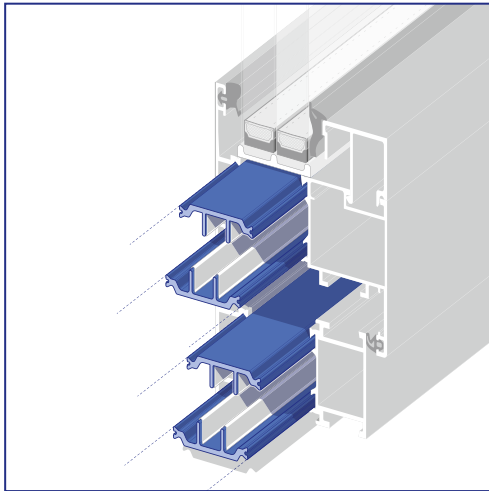

Low-emissivity foil

As requirements for energy saving increase, innovations must rise to the challenge. Designing a system with inner fins (commonly addressed as ‘noses’) is a big step towards reducing convection, but it doesn’t end there. Adding so-called ‘low-e’ foil to the inner fins in thermally broken systems lowers the U-value even further, with a radiant heat reduction and emissivity of $\epsilon = 0.02$ according to EN ISO 10456. This simple but effective solution can withstand 200 °C (392 °F), offers an excellent price-to-value ratio and can even be powder-coated or anodized.

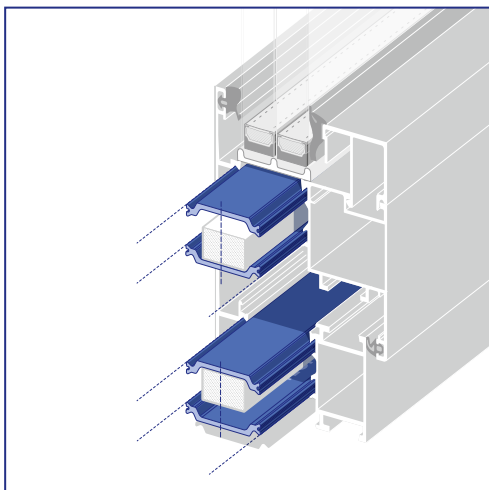

Polyamide foam

To further reduce U-values, foam can be added to a system – new or already existing – without changing the design. What cannot happen, however, is that this causes increased material or handling complexity. Our answer to this challenge? A closed-cell, powder-coatable polyamide foam, which requires no additional handling from you. Environmentally protective with low levels of waste and the ability to be recycled with little effort, this chemically resistant foam solution has a lambda value of 0.036 W/(mK).

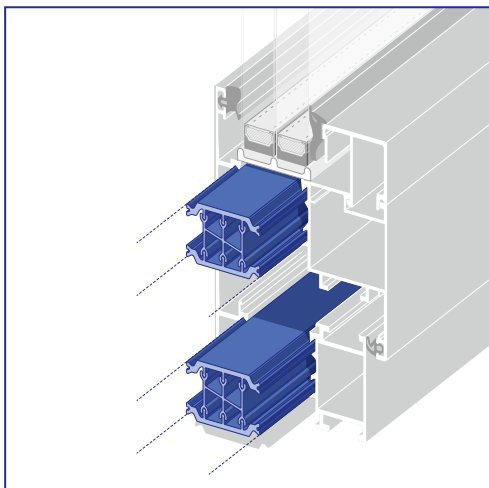

Package solution

Systems requiring thermal breaks present two main challenges: stability and heat loss. We created our package solution to achieve thermal optimization without structural compromise. Our compound of profiles is geometrically chambered, like a web, resulting in a labyrinth-like inner profile that reduces convection and provides the required mechanical stability and performance.

Our principle: we optimize your processes and you have more time for the important things.

Insulation for aluminum windows, doors and facades can always be optimized and improved to hit peak performance. Our specialized processing methods can streamline your workflow and leave you to focus on the rest.

Small improvements for big impact

On the production line, small changes to processes can make all the difference. Removing steps and reducing effort might seem like small considerations in the grand scheme of things, but they can have a big impact. Protecting and coating profiles is difficult during production, and many processing additions require extra steps that can cost time and money. To help you overcome these, we developed solutions that ensure that our profiles maintain a high surface quality, accept paint evenly and easily, and don't lose their intended visual appearance in the construction process. Small, innovative solutions that streamline your processing flow and help you get the job done.

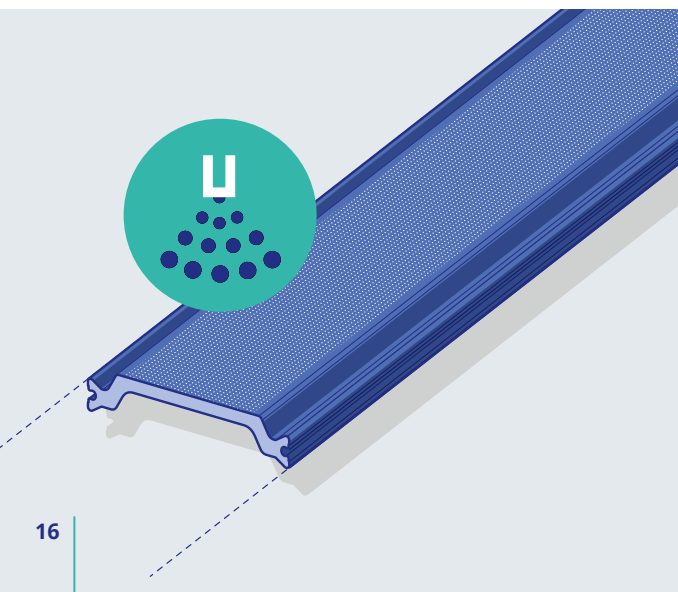

Sandblasting

Visual appearance is a key part of the result in a building. Components are often powder-coated, which works well, but can present problems with the evenness of adhesion of the powder. We can sandblast our profiles, roughening the surface and thus achieving an evenness of adhesion, meaning a lower rejection rate in production.

Adhesive film

Maintaining the visual appearance of a smoothly produced profile presents a different aesthetic challenge. Supplying profiles with an adhesive film already applied protects them during the coating process, and means they remain looking as smooth and high-quality as they did when they left the plant.

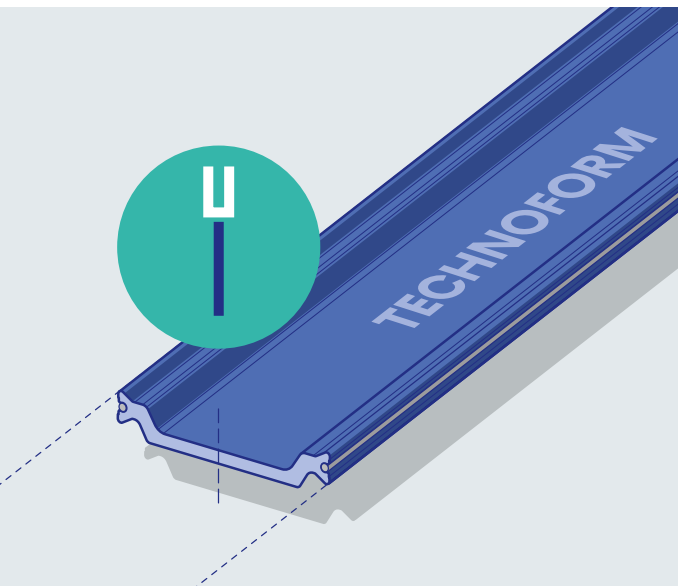
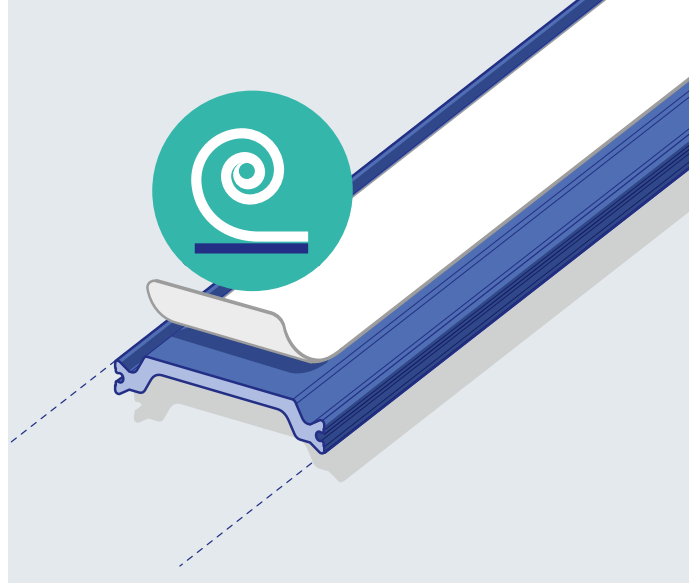

Lasermarking

Sometimes it's little touches that add quality and functionality to a product. By having your profiles lasermarked, you can increase your brand visibility, adding value to your products, or simply make them easier to trace for improved logistics and quality control.

Glue wire

If you need to add extra steps to your production process, we know that this can be a drain on time and money. Adding glue wire to a profile reduces the loss of shear strength due to powder coating, and we can pre-install it for you, meaning no extra processes or added headaches on your end.

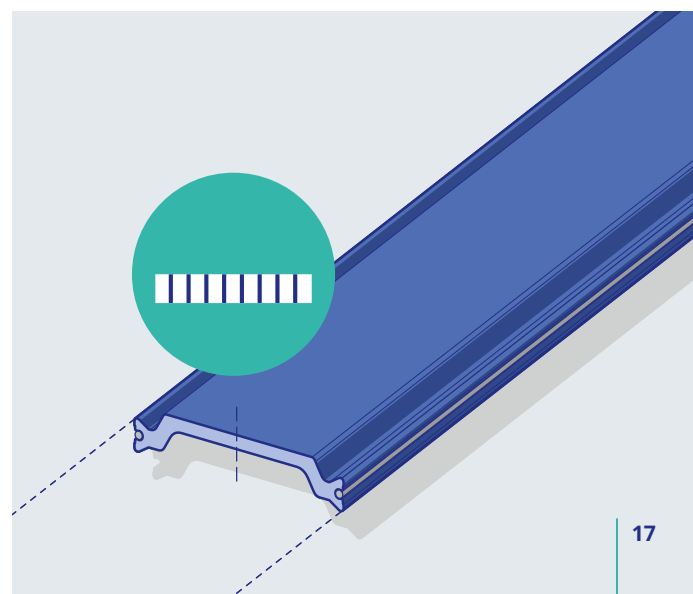

Your challenge is our motivation.

Specific challenges require specific solutions, read how we tackle conundrums in the windows, doors, and facades industry to ensure you are regulation compliant & have optimum performance in complex applications.

Innovating to overcome particular challenges

Sometimes, markets and applications call for very particular solutions. We are passionate about problem solving and put our minds to even the most specific of challenges to deliver you the quality you expect in the form that you need it. Whether that is complying with particular regulatory requirements, innovations to overcome temperature phenomena, or devising methods for complex application, we engage with you to isolate and address the challenge at hand.

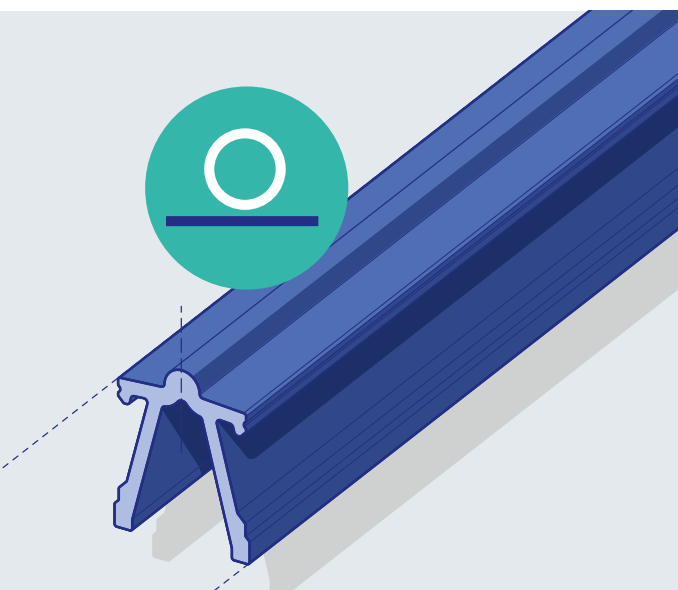

Solutions for sliding windows and doors

Sliding windows and doors are a common choice in modern buildings placing emphasis on a balance between aesthetics and functionality. Preserving thermal optimization whilst maximizing visual minimalism and mechanical functionality is a complex challenge. To achieve this, our profiles are produced to tight tolerances with exact contours and geometry, and also have an optimally smooth surface to allow friction-free movement. We have several different profiles for sliding windows and doors in our standard profiles catalogue.

We continuously innovate to bring greater value-add in our products.

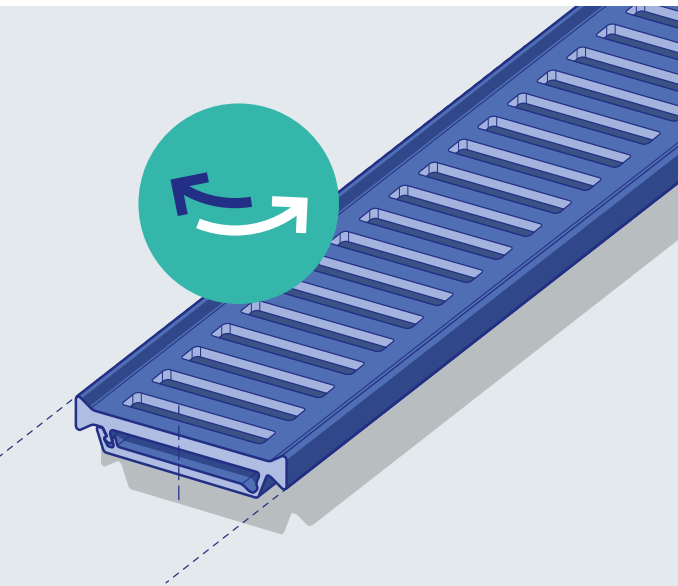

Anti Bi-Metal

The so-called bi-metallic effect occurs when there is a large difference in temperature between the inner and outer frame of a door (e.g. through intense sunlight). The outer frame expands and can cause distortion of the door and locking difficulties. Our solution allows the outer frame to expand with only minimum affect to the fit of the inner frame, meaning it continues to function as normal. Easily replaced, this addition comes pre-installed, meaning there is no change to the process on your side.

Drainage

French NF P24-301 regulation stipulates that windows must have drainage holes for water to filter through the profiles. By supplying profiles with drainage holes means that fabricators do not need to drill these holes themselves, thereby adding value to the product they sell.

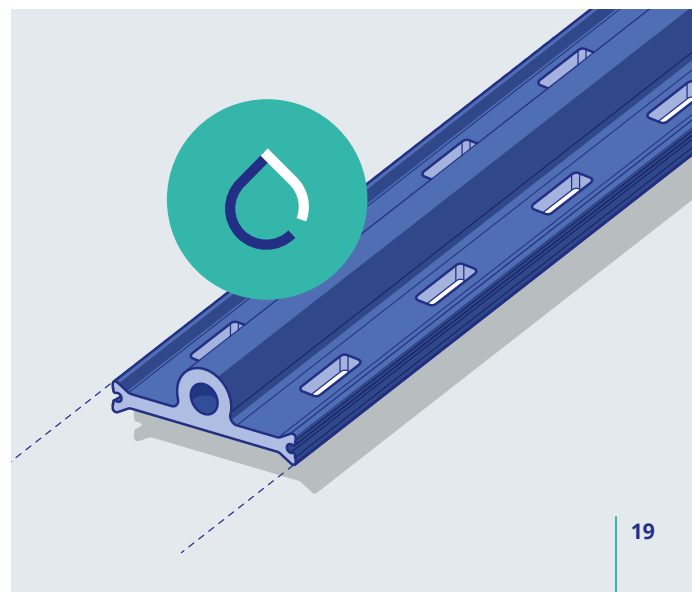

Facade solutions – boosting intelligence in modern buildings

Lightweight, durable, stylish: when it comes to the exteriors of office buildings and other large-scale construction projects, aluminum is frequently the material of choice. Aside from the visual aspects we take a step further to a more intelligent construction. Our aluminum facade solutions for external wall insulation help improve the thermal performance of this popular material. And we do it for a reason. Just relax and let us optimize your facades for full peace of mind.

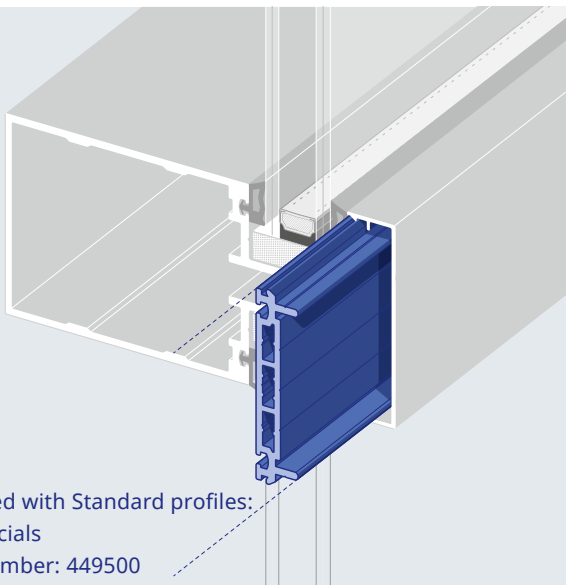

Stick facades

For stick-facades, we offer a variety of more than 20 different standard polyamide spacers and pressure plates. To be more precise: our solutions drive best-in-class thermal performance with U-values as low as $1 \text{ W}/(\text{m}^2\text{K})$.

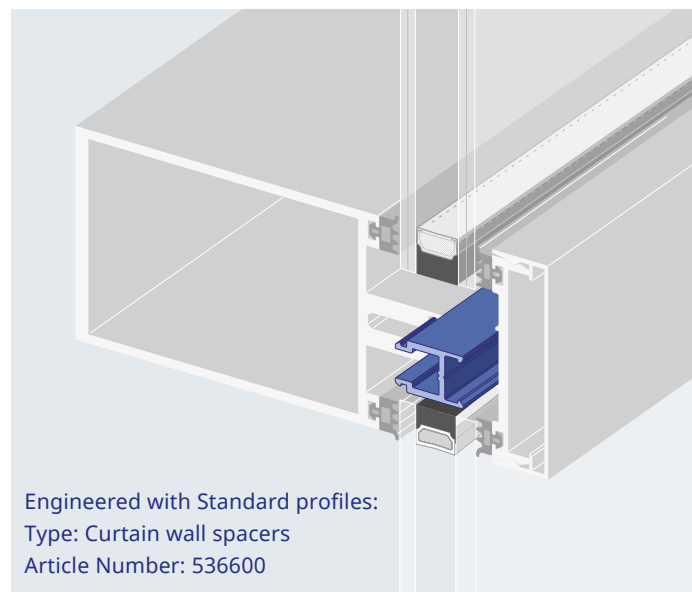

Engineered with Standard profiles:
Type: Curtain wall spacers
Article Number: 536600

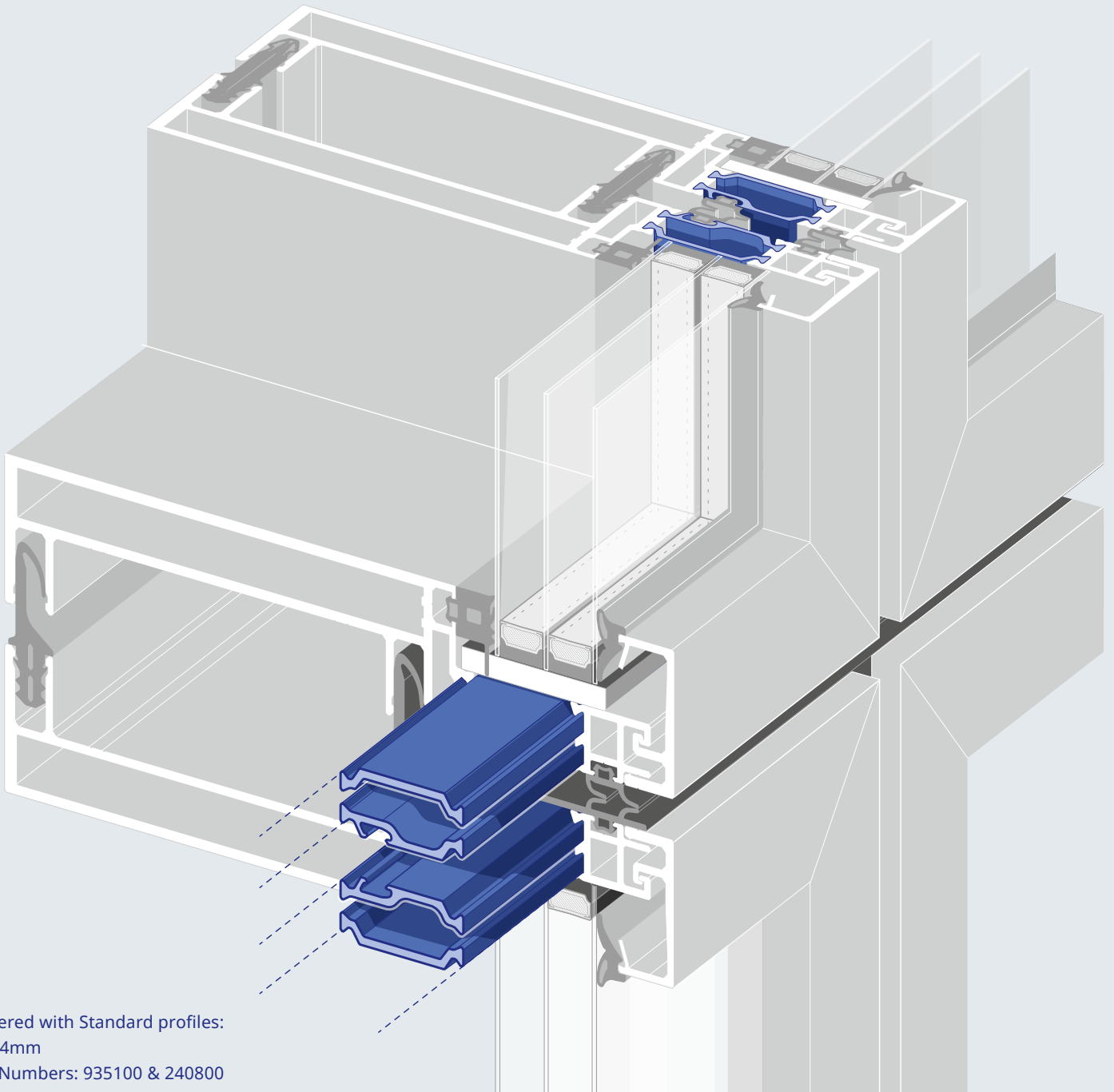

Engineered with Standard profiles:
 Type: 34mm
 Article Numbers: 935100 & 240800

Unitized facades

All our insulating solutions for windows are suitable for unitized facades and we have special polyamide glass edge profiles for new systems.

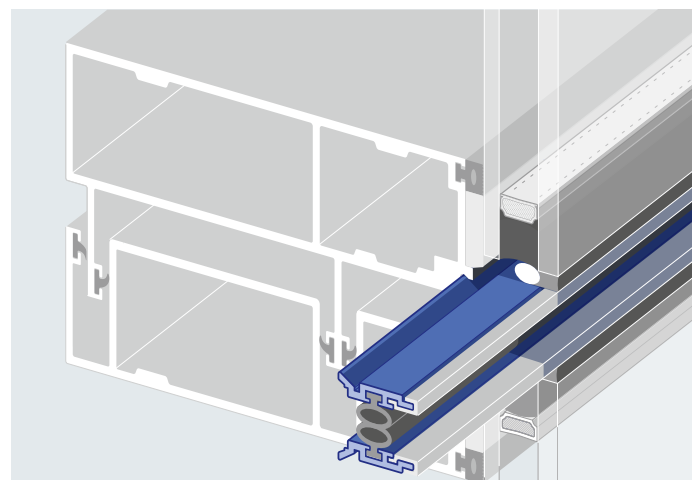

Engineered with Standard profiles:
 Type: Edge Cover
 Article Number: 527300

Our materials – always rely on the best

When it comes to our materials, you can be assured that we are only satisfied with the best. Thus, we offer a major material variety to find the perfectly tailored solutions for every project. High precision for processing, compatibility, environmentally friendly production and best mechanical performance are just some of the characteristics you can rely on.

No matter if it is about mechanical values, global warming potential or thermal performance, we will be delighted to advise you.

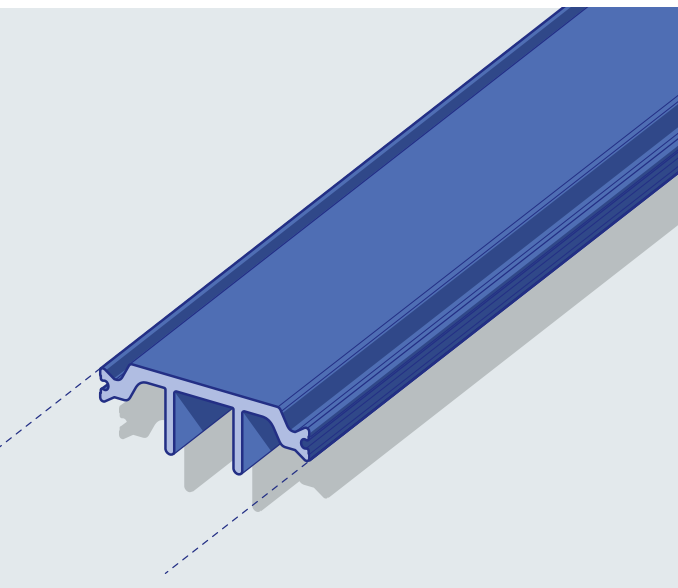

Standard Polyamide / PA 66 GF25

With our standard polyamide we guarantee unlimited availability and recyclability as well as excellent performance to match your needs.

Bio-based Polyamide

Our renewable materials offer a great opportunity to significantly reduce your carbon footprint and provide you with the best global warming potential (GWP) around.

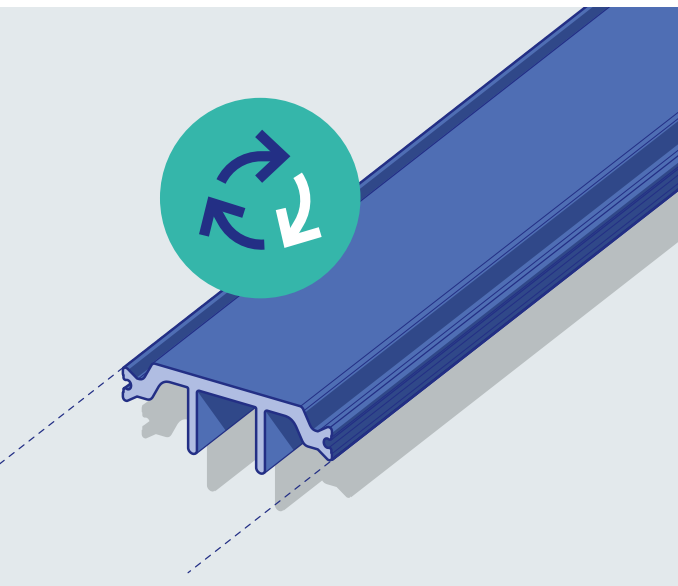
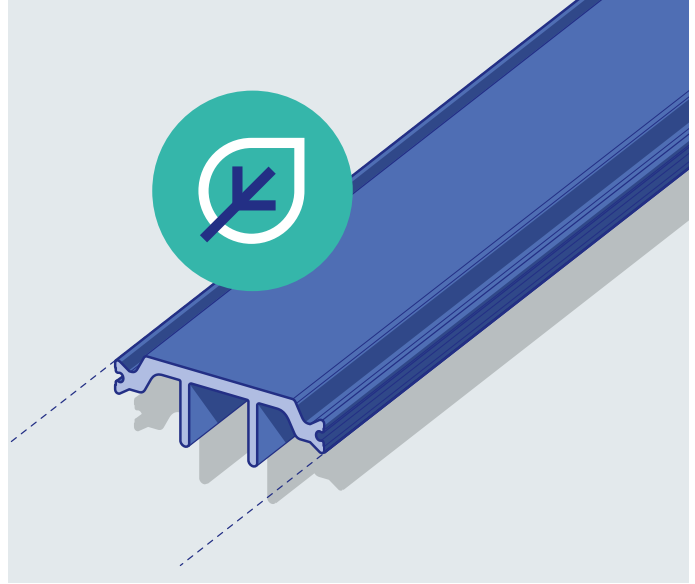

Recycled Polyamide

To take a step further in the increased use of eco-friendly materials, we offer recycled polyamide that fulfills our high quality and processing standards.

More materials in the pipeline..

With our innovative Low Lambda Polyamide you get a certified and reliable Lambda value of 0.21 W/(mK) and with it the best all-around solution.

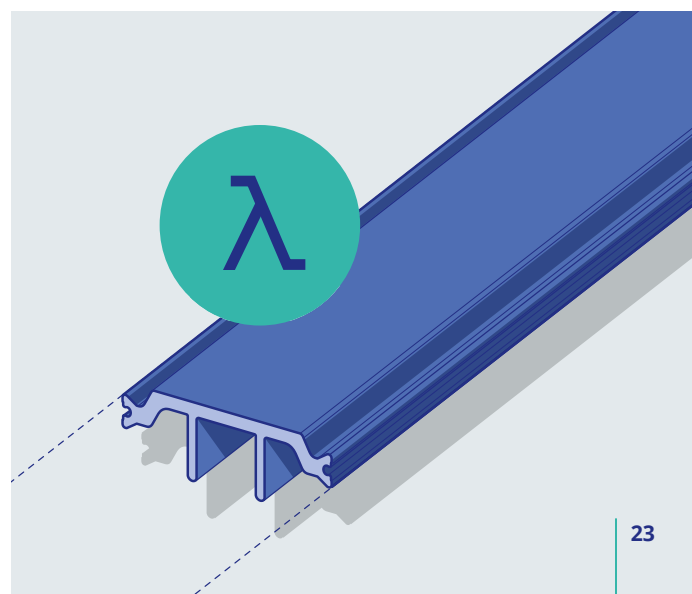

Thermal calculation

From the beginning of thermal break history, Technoform has always been ready to take up your challenges, supporting each of your developments with the help of thermal calculations. Through the years, we have contributed proactively to the development of different systems, pushing the limits of thermal performance.

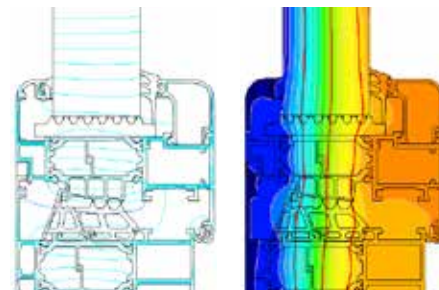

The increase of complexity of the systems together with increasingly strict standard requirements places us in front of new challenges to continue improving our support. Daily we work with the most wellknown FEA software on the market, enlarging our know-how and offering you our innovative solutions and designs. Years of positive experiences

with our customers using BISCO, flixo, WinIso and THERM allow us to give you the most reliable results in window and frame thermal transmittance, every time. Following your needs, we can perform calculations using the most suitable software to give you accurate results according to worldwide calculation methods and standards.

Mechanical simulation

Being in the window, door, and facade market for over 40 years, we experienced the evolution of the market. Today, we see a consistent market trend towards an increase of innovative and special solutions.

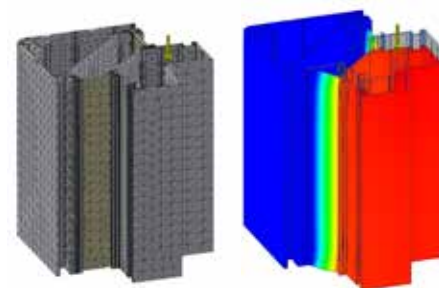

This leads to a growing complexity in the design process with a strip that is taking not only the function of a thermal barrier, but also structural requirements, requiring a deep knowledge of material properties. Therefore, the know-how of mechanical performance is getting more and more crucial. Predicting the behaviour of a complex system during the design process can be a great advantage

to reduce development time/costs and have the assurance of best quality. To be ready to take up your challenges, we have a new tool to develop your ideas. We now use a FEA software for mechanical simulation which allows us to get the best mechanical solution for your thermal break and a reliable forecast of behaviour of the assembled system, according to EN 14024.

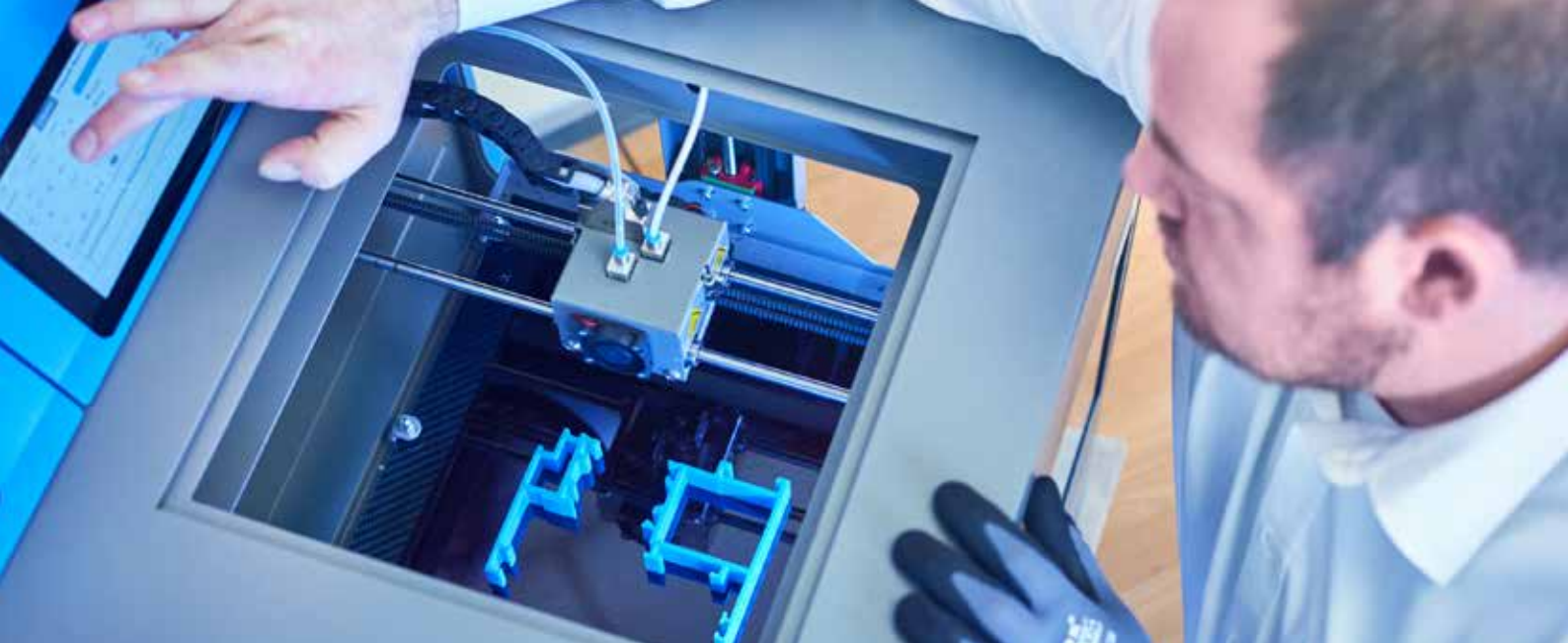

Service, support, and testing – on profiles and all-round advisory service

Virtual product development will not be the end of your product development with Technoform. Our advanced tooling and extrusion technologies permit rapid, high-quality samples, made of the requested material with real, verified production tolerances, surface quality and mechanical stability.

Our support, your solution

Using samples you can test your solutions by creating a realistic model to check their functionality and verifying the suitability of the product, directly inside your company. During this phase, we support you with our 40 years of experience in the thermal break market. Our engineers can support you during the assembly procedures, surface treatment processes, and other critical steps. We are always available for suggestions and recommendations to deliver the best solution for your products.

The most modern checking and testing procedures are available for our customers to always guarantee a product of highest quality.

- Determination of the mechanical performance of metal profile with thermal barrier according to EN 14024: transverse tensile strength, shear strength, elasticity constant, deformation after aging
- Determination of material properties: Young's modulus, impact strength, ShoreD hardness, density, water content, electrical resistance
- Determination of glass fibre content, length and distribution
- Determination of heat conductivity
- Dimensional check with 3d scanner
- Differential scanning Calorimetry (DSC) to detect material properties
- Microscoping inspection with sample preparation
- Surface treatments: powder coating/anodization test

Cooperation partners

France

- CSTB · Centre Scientifique et Technique du Bâtiment
- SNFA · Syndicat National de la Construction des Fenêtres, Façades et Activités Associées

Germany

- IFT-Rosenheim · Institut für Fenstertechnik e. V.
- FIW-München · Forschungsinstitut für Wärmeschutz e. V.
- IFZ · Informationszentrum Fenster Türen Fassaden e. V.
- VFF · Verband der Fenster- und Fassadenhersteller
- Bundesdeutscher Arbeitskreis für Umweltbewusstes Management (B.A.U.M.) e. V.
- A/U/F Aluminium und Umwelt im Fenster- und Fassadenbau
- EPEA Internationale Umweltforschung GmbH
- Deutsche Gesellschaft für Nachhaltiges Bauen

Great Britain

- CAB · Council for Aluminum in Building
- BFRC · British Fenestration Rating Council

Portugal

- ANFAJE · Associação Nacional dos Fabricantes de Janelas Eficientes

Italy

- UNICMI · Unione nazionale delle Industrie delle Costruzioni Metalliche dell'Involucro e dei serramenti
- AITAL / QUALITAL · Associazione Italiana Trattamenti superficiali Alluminio / Organismo di Certificazione

Spain

- AEA · Asociación Española del Aluminio y Tratamientos de Superficie
- ASEFAVE · Asociación Española de Fabricantes de Fachadas Ligeras y Ventanas
- Tecnalia Research & Innovation

- ENSATEC · Laboratorio de Ensayos Tecnológicos

Europe

- Federation of European Window and Curtain Wall Manufacturers' Associations

North America

- AAMA · American Architectural Manufacturers Assn.
- GANA · Glass Association of North America
- NFRC · National Fenestration Rating Council

South America

- CAIAMA · Cámara Argentina de la Industria del Aluminio y Metales Afines.
- Brasil AFEAL · Associação Nacional de Fabricantes de Esquadrias de Alumínio.

China

- CAIGA · China Architectural and Industrial Glass Assn.
- CCMISA · China Construction Metal Structure Assn.
- Hong Kong Facade Association
- National Committee of Standardization for Non-ferrous Metals

Singapore

- SGBC · Singapore Green Building Council
- BCA · Building and Construction Authority of Singapore
- ESI · Energy Studies Institute – National University of Singapore
- CoolestSG

Korea

- KAFA · Korea Architectural Facade Association

Australia & New Zealand

- Window Association of New Zealand
- Australian Window Association
- AGGA · Australian Glass and Glazing Association

Certifications



Europe

TÜV Certification

according to ISO 9001: 2015
Cradle to Cradle Certified™
Gold

Germany

TÜV Certification

according to
ISO 14001: 2015
ISO 50001: 2011
ISO 45001:2018

Belgium

ATG Certification

Russia

GOST Certification

Cradle to Cradle Certified™
Gold

China

TÜV Certification

according to
ISO 14001:2015
ISO 9001:2015
ISO 45001:2018

Hong Kong

TÜV Certification

according to
ISO 14001:2015
ISO 9001:2015
ISO 45001:2018

Singapore

Singapore Green Building Product – Excellent

Closer than you may think – you find us all over the world

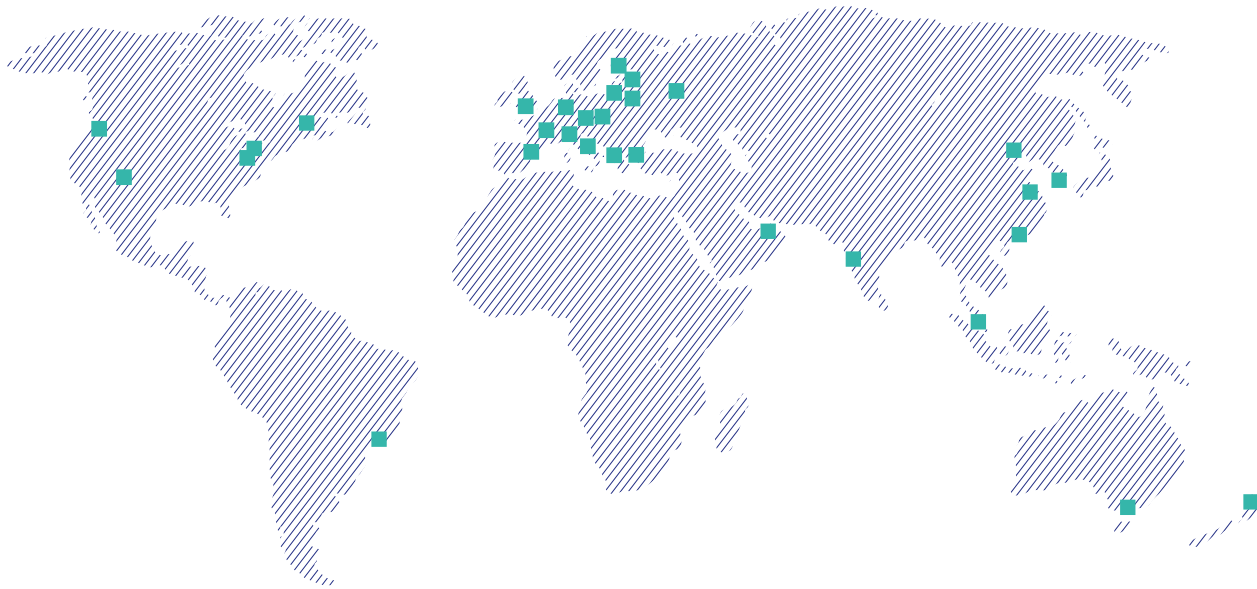

Germany
Telephone: +49 561 9583400

Telephone: +49 561 207530

France
Telephone: +33 472 689580

Great Britain
Telephone: +44 1789 761323

Russia
Telephone: +7 495 9337153

Italy
Telephone: +39 02 9375 721

Greece
Telephone: +30 2310 720286

Balkans
Telephone: +90 212 6698281

Turkey
Telephone: +90 212 6698281

Spain
Telephone: +34 932 386 438

Telephone: +34 983 796 632

Middle East
Telephone: +971 4 3215615

India
Telephone: +91 96 19333880

China
Telephone: +86 512 62833188

Telephone: +86 010 65907177

Telephone: +86 755 26727912

Telephone: +86 21 62611991

Telephone: +86 24 23963791

Telephone: +852 2665 6322

Telephone: +86 28 84397818

Telephone: +86 139 5240 2431

Telephone: +86 183 0621 2579

Telephone: +86 183 6275 2519

Telephone: +86 183 0621 3160

Korea
Telephone: +82 2 5017357

Japan
Telephone: +81 3 55799454

Singapore
Telephone: +65 62739595

Taiwan
Telephone: +886 95 5900727

New Zealand
Telephone: +64 9415 9050

Australia
Telephone: +61 3 88445582

North America
Telephone: +1 330 4876600

Telephone: +1 971 8320502

Telephone: +1 423 2021812

South America
Telephone: +55 11 9925 22708

TECHNOFORM

www.technoform.com